

Instruction manual

FA 515 Ex

Stationary dew point sensor for measuring pressure dew-point and atmospheric dew point for explosive areas..



This manual is part of the scope of delivery and is intended to ensure the optimum operation and function of the device.

CS Instruments GmbH & Co.KG. accepts no liability for this publication and does not accept any liability for improper handling of the described products.

In order to guarantee a perfect function, the operating instructions must be carefully read and observed before operating the dew point sensor. It must be brought to the attention of all persons who are responsible for assembly, commissioning, operation, inspection, maintenance and repair.

CS Instruments GmbH & Co.KG reserves the right, at any time and without prior notice, to make changes without the obligation to retrofit models manufactured before the modification date. For this reason we kindly ask you to specify the device number, designation and type, which can be read on the type plate.

© Copyright CS Instruments GmbH & Co.KG.
All rights reserved.

1 Table of content

1	Table of content.....	3
2	Pictograms and Symbols	4
3	Signalworte nach ISO 3864 und ANSI Z 535	4
4	General	5
5	Identification / Labeling	5
5.1	Produktlabel.....	5
5.2	ATEX-Label	5
6	Certification ATEX	5
7	Technische Daten	6
8	Dimension	7
9	Safety instructions	8
9.1	General safety instructions	8
9.2	Environmental aspects	8
10	Installation	9
10.1	General	9
10.2	Hazardous areas (explosive media).	10
11	Electrical wiring	11
11.1	Connector pin assignment.....	11
11.2	Connection diagram	11
12	Connection cable	11
13	Calibration / Adjusting	12
14	Warranty.....	12
15	Bestelldaten	13

2 Pictograms and Symbols



General Warning symbol (Danger, Warning, Caution)



Hazardous area
Important notes for use in potentially explosive atmosphere



General note



Installation- and Instruction manual to consider (on Nameplate)



Installation- and Instruction manual to consider

3 Signalworte nach ISO 3864 und ANSI Z 535

Danger!	Imminent danger As a consequence of incorrect handling: serious personal injury or death
Warning!	Possible hazard As a consequence of incorrect handling: possible serious injury or death
Caution!	Imminent hazard As a consequence of incorrect handling: possible personal injury or damage
Note!	Possible hazard As a consequence of incorrect handling: possible personal injury or damage
Important!	Additional notes, information, tips As a consequence of incorrect handling: Disadvantages in operation and maintenance, no danger

4 General

The FA 515 Ex is a 4-20 mA loop powered measuring instrument (2-wire technology), which generates a 4...20mA current signal corresponding to the humidity at the analogue output.

The assignment and scaling of the output signal 4 to 20 mA takes place during production. Possible starting signals are: ° Ctd, ° Ftd, % rF, ° C, ° F, g / m³, mg / m³, g / kg, ppm

5 Identification / Labeling

The dew point sensor FA 515 Ex is marked with 2 nameplates Product- und ATEX Label.

5.1 Product label

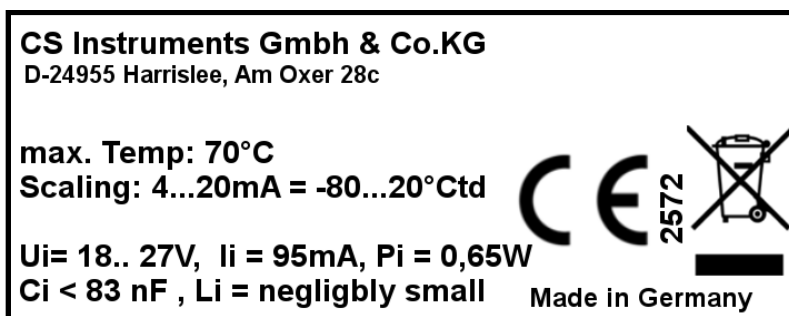

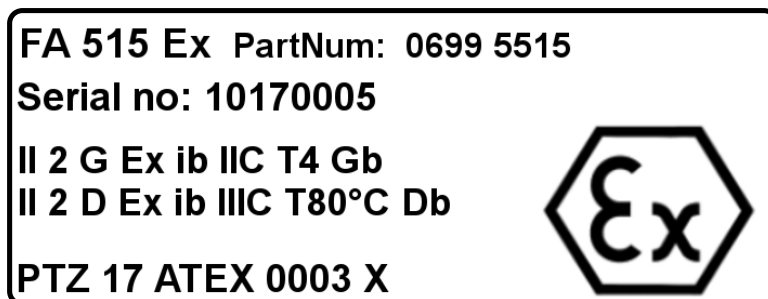

5.2 ATEX-Label



6 Certification ATEX

The FA 515 Ex dew point sensor has been tested and certified according to the ATEX directives 2014/34 / EU of intrinsically safe equipment.

	II 2 G Ex ib IIC T4 Gb	Zone 1, Gas, intrinsically safe, temp. 135°C
	II 2 D Ex ib IIIC T80°C Db	Zone 21, dust, intrinsically safe, temp. 80°C

Applied standards:

- EN 1127-1:2011
- EN 60079-0:2012+A11:2013
- EN 60079-11:2012

7 Technische Daten

Measuring range	-	80...50 °Ctd pressure dew point resp. dew point in °Ctd 0...100 % RH -20...70 °C
Accuracy:		typical ± 1 °Ctd von 20...-20 °Ctd ± 2 °Ctd von -50...-20 °Ctd ± 3 °Ctd von -50...-80 °Ctd
Pressure range:		-1...500 bar standard
Power supply:		24V VDC (18..28 VDC)
Output:		4...20 mA 2-wire technology
Protection class:		IP 65
EMV:		DIN EN 61326-1
Operating temperature:		-20...70 °C (ideal 0...50 °C)
Storage temperature:		-40...80 °C
Load for analogue output:		< 500 Ohm
Screw-in thread:		G 1/2" stainless steel Optional: UNF 5/8" or NPT 1/2"
Material of housing:		zinc alloy
Sensor protection:		sinter filter 50 μ m stainless steel
Connection:		M12, 4-pole
Response time t95:		< 30 seconds (descending) < 10 seconds (ascending)
max. working resistance of analogue signal:		500R bei 24V
max. Input Voltage U_i :		28 V
max. Input current I_i :		93 mA
max. Input power P_i :		0,65 W
max. effective inner capacity C_i :		83nF
max. effective inner inductance L_i :		Neglectable

The provided EC approval certificate Primara "PTZ 17 ATEX 0003 X" is to be considered.

8 Dimension

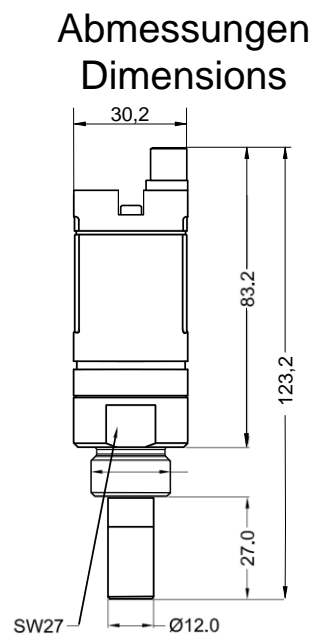
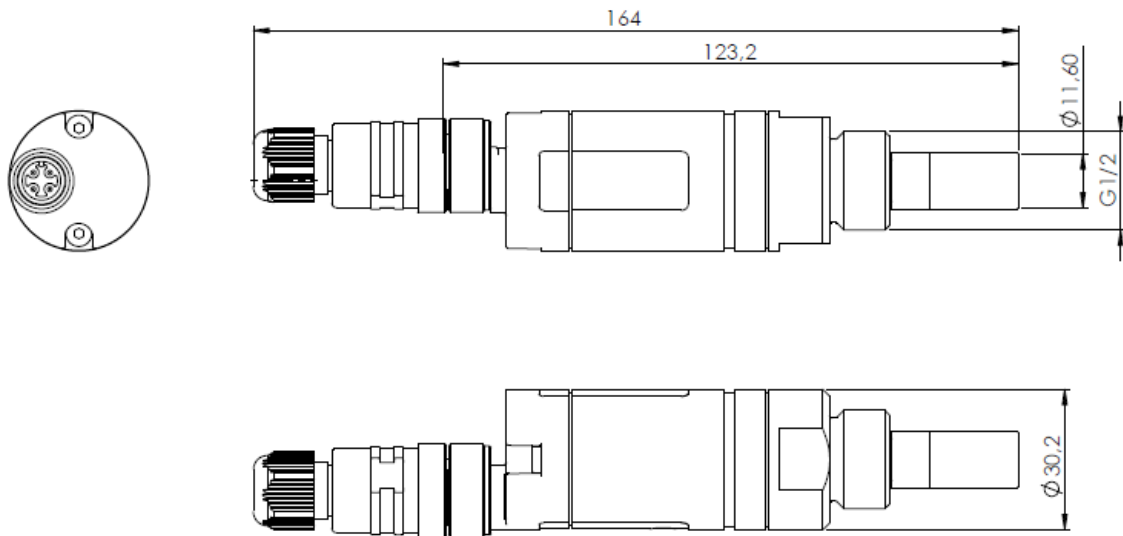



9 Safety instructions

9.1 General safety instructions

Please read prior to operation!

- Improper handling can result in significant personal injury and damage. All activities described in this operating instructions manual must be carried out only by qualified personnel qualifications described below..

Professionals (Technical staff)

The technical staff is based on his education/training, his knowledge of measurement and control technology as well of the local regulations, standards and guidelines in the position to do the work as described and to identify the possible hazards.

Special working conditions require further appropriate knowledge, e.g. gas hazardous areas (explosive media).

- This manual must always be available to all persons involved in the assembly, commissioning, operation and maintenance.
- Technical modifications to the FA 515 Ex are not permitted..
- Warning: Don't exceed pressure range of 50 bar.
- Observe the measuring range of the FA 515 Ex! If overheating, the sensor is destroyed.
- Observe max. storage and transport temperature as well as max. operating temperature.
- Warranty claims no longer apply if instrument is opened, in case of inexpert handling or use of force.
- Important: Prior to installation, briefly allow compressed air to escape to remove condensate and particles. Prevents the contamination of the FA 515 Ex. Standing air leads to long measuring times.

9.2 Environmental aspects

When disposing of the FA 515 Ex, the individual separation of the individual components must be ensured. The electronics must be collected in electronic waste and disposed of in a professional manner.

10 Installation

10.1 General

Remark: The sensor must be connected in strain less state only



- The direct installation of the sensor is only allowed in the unpressurized state of the system
- The sensor must be tightened with a torque of 25 - 30 Nm.
- Tightness of the connection must be checked and ensured.
- It is not permitted to use a sealing ring with a NPT 1/2" thread. Appropriate PTFE sealing tape or sealant should be used instead

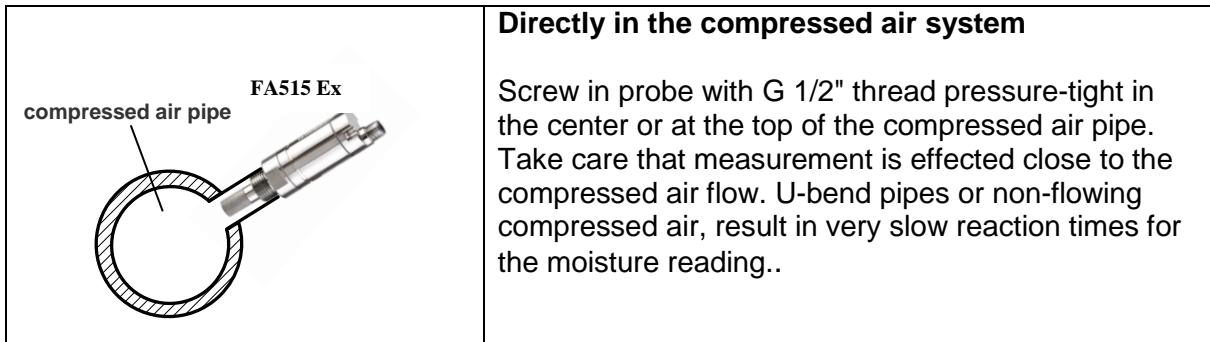

10.2 Hazardous areas (explosive media).



- Humidity/Dew point transmitter FA 515 Ex is only allowed to be connected to an intrinsic safe circuit, in which an electrically isolated supply and signal circuit in the power supply is preferred.
- Associated equipment without galvanic isolation according to EN 60079-11 may only be used if a potential equalization is performed along the entire power cable.
The corresponding requirements according to EN 60079-14 must be complied with.
- During the installation of the devices in areas of the IIC gas group, it must be ensured that impact and frictional sparks are not to be expected even in rare incidents.
- Requirements intrinsically safe feeding unit
 - $U_0 = 28 \text{ V max.}$
 - $I_0 = 93 \text{ mA max.}$
 - $P_0 = 0,65 \text{ W max.}$

The maximum effective inner capacity of FA 515 Ex is 83nF, the maximum effective inner inductance is neglect able.

11 Electrical wiring

11.1 Connector pin assignment

		Pin 1	Pin 2**	Pin 3	Pin 4**
FA 515 Ex	Connector plug	+VB	NC	-VB	NC
		brown	white	blue	black

+VB	Positive supply voltage 24VDC (18...28 VDC) smoothed
-VB	Negative supply voltage
NC	Not connected

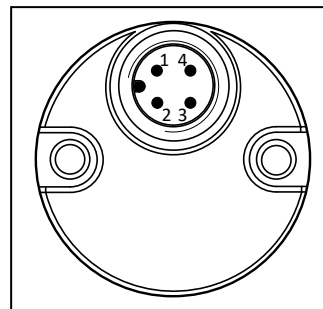

11.2 Connection diagram

FA 515 Ex

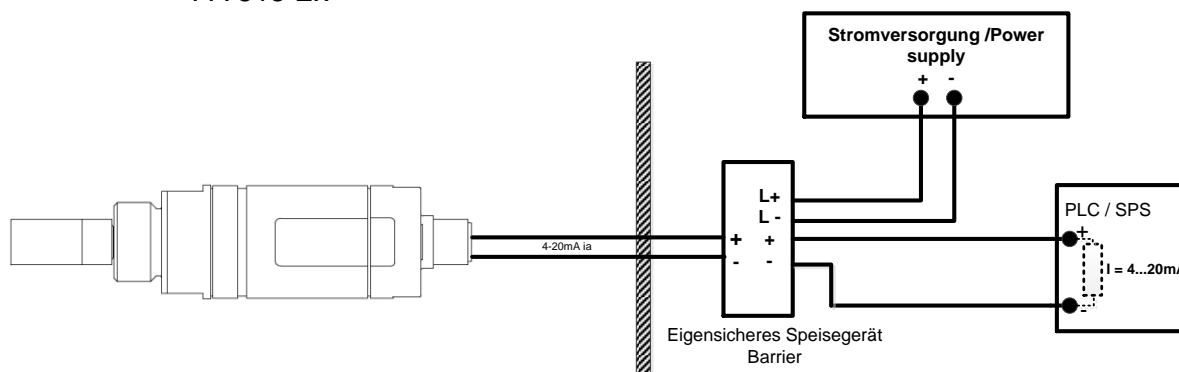

Installation, electrical connection, commissioning, operation and maintenance in hazardous areas only be carried out by trained personnel authorized by the plant operator.

12 Connection cable



For a cable laying in areas with high radiation (EMC).a shielded cable must be used.



The cable used must meet the following specifications for ATEX

- Cable diameter:
 - Max. cross-section:
 - Single strand diameter:
 - Test voltage wire-wire:
 - Test voltage wire -shield:
(when using a shielded cable)
 - Flame retardancy according to IEC 60332-1-2
- | |
|----------------------|
| 4-6.5mm |
| 0.75 mm ² |
| ≥ 0.1mm |
| ≥ 500V AC eff. |
| ≥ 500V AC eff |

13 Calibration / Adjusting

From the manufacturer

We recommend to calibrate and, if necessary, adjust the FA 515 Ex at regular intervals within the scope of the DIN ISO certification. The calibration cycles should follow your internal specification. Within the framework of DIN ISO certification, we recommend a calibration cycle of one year for the FA 515 Ex.

14 Warranty

If you have reason for complaint, we will of course repair any faults free of charge if it can be proven that they are manufacturing faults. The fault should be reported immediately after it has been found and within the warranty time guaranteed by us. Excluded from this warranty is damage caused by improper use and non-adherence to the instruction manual.

The warranty is also cancelled once the measuring instrument has been opened provided this is not described in the instruction manual for maintenance purposes. This is also the case if the serial number has been changed, damaged or removed.

The warranty time for FA 515 Ex is 12 months for the instruments and 6 months for accessories if no other terms are agreed upon. Warranty services do not extend the warranty time.

If in addition to the warranty service necessary repairs, adjustments or similar are carried out, the warranty services are free of charge but there is a charge for other services such as transport and packing costs. Other claims, especially those for damage occurring outside the instrument are not included unless responsibility is legally binding.

After-sales service after the warranty time has elapsed

We are, of course, there for you after the warranty time has elapsed. In the case of function faults please send us your measuring instrument with a brief description of the defect. Please also indicate your telephone number so that we can contact you if necessary.

15 Bestelldaten

<i>Order No.</i>	<i>Order data</i>
0695.5150	FA515 Ex Taupunktsensor (-80...20 °Ctd)
0699.3396	Precision calibration at -40°Ctd incl. certificate
0554.3071	Intrinsically safe power supply, safety barriers

CS INSTRUMENTS GmbH & Co.KG

Sales Office South / Geschäftsstelle Süd/

Zindelsteiner Str. 15
D-78052 VS-Tannheim

Tel.: +49 (0) 7705 978 99 0

Fax: +49 (0) 7705 978 99 20

Mail: info@cs-instruments.com

Web: <http://www.cs-instruments.com>

Sales Office North / Geschäftsstelle Nord

Am Oxer 28c
D-24955 Harrislee

Tel.: +49 (0) 461 700 20 25

Fax: +49 (0) 461 700 20 26

Mail: info@cs-instruments.com

Web: <http://www.cs-instruments.com>